

**Custom Seal (PVC)
Mechanically Attached System - Single Weld
Specifications**

1.01 DESCRIPTION

- A. This system is a mechanically attached system design utilizing .048 mil (1.2mm) & .060 mil (1.5mm) nominal thickness Custom Seal (PVC) roofing membrane in a single weld configuration over an approved mechanically secured insulation or applied directly over an approved substrate.
- B. Roof Application and related work shall be installed by a single firm authorized by the roofing manufacturer. A single firm is required so that there is undivided responsibility for performance of all Custom Seal supplied roof components.
- C. Furnish and install the Custom Seal thermoplastic membrane roofing system in strict accordance with drawings and specifications approved by Custom Seal Roofing Systems.
- D. Related Work
The work includes, but is not necessarily limited to the installation of:
 - 1. Vapor Retarders (where required)
 - 2. Custom Seal Insulation
 - 3. Custom Seal Anchor Bars
 - 4. Custom Seal slip sheet
 - 5. Custom Seal Fasteners
 - 6. Custom Seal Roof Membrane
 - 7. Custom Seal Flashing
 - 8. Custom Seal Metal Flashing
 - 9. Wood Nailer
 - 10. Custom Seal Walkways
 - 11. Custom Seal Approved Sealants
 - 12. Custom Seal Adhesives
 - 13. Metal Coping (as required)

1.02 QUALITY ASSURANCE

- A. This roofing system must be installed by an authorized Custom Seal Roofing Systems (PVC) applicator.
- B. There shall be no deviation made from this specification or the detail drawings without written approval from Custom Seal Roofing Systems 14 days prior to the start of the roofing project.
- C. Upon completion of the installation, an inspection shall be conducted by a Technical Representative of Custom Seal Roofing Systems to ascertain that the roofing system has been installed according to Custom Seal Roofing Systems most current published specifications and details. This inspection is not intended to be a final inspection for the benefit of the owner but for the benefit of Custom Seal Roofing Systems to determine whether a warranty shall be issued.
- D. It is the roofing applicator's responsibility to adhere to all applicable building codes (local and national) for roofing system installation requirements and limitations in their local areas applicable at the time of the bid.
- E. For specific code and testing agency approvals achieved by Custom Seal Roofing Systems, refer to the published listings or call Custom Seal Roofing Systems Technical Department at 1-800-370-7325.

1.03 SUBMITTALS

- A. Submit a "Pre-Job Survey" to Custom Seal Roofing Systems Technical Department for approval PRIOR to the job start to enable the Technical Department to approve and assign a job number to the project.
 - 1. The "Pre-Job Survey" must be filled out completely and accurately to include any prior deviations approved from this specification.
 - 2. A roof drawing or shop drawing may be provided to the Technical Department with each "Pre-Job Survey". Drawings must show dimensions and all penetrations.
- B. When Material & Workmanship warranties are desired, it is recommended Custom Seal Roofing Systems be contacted PRIOR to project bid and installation regarding system requirements. Information may be required for the wind design of the system.

1.04 PRODUCT DELIVERY, STORAGE AND HANDLING

- A. Deliver materials in original, unopened containers.
- B. Containers shall be labeled with manufacturer's name, brand name, installation instructions and identification of various items.
- C. All materials, except membrane, must be stored between 16°C (60°F) and 27°C (80°F). If exposed to lower temperatures, restore to 16°C (60°F) minimum temperature before using.
- D. Store all materials, including membrane, in a dry protected area. Damaged materials must not be used. Installed materials found to be damaged shall be replaced at contractor's expense.
- E. Store the membrane in a manner to protect it from abrasion or puncture.
- F. It is recommended that insulation is stored on skids (or insulation bunking) and completely covered with a breathable material such as a tarp or canvas if the insulation is not installed the same day as being loaded on the roof.

1.05 JOB CONDITIONS (CAUTIONS AND WARNINGS)

Prior to the use of any Custom Seal Roofing Systems product, consult Material Safety Data Sheets for applicable cautions and warnings.

- A. Do not use oil base or bituminous base roof cement with Custom Seal (PVC) materials.
- B. Do not install Custom Seal (PVC) membrane directly over asphalt or smooth surfaced modified bitumen without consulting the Custom Seal Technical Services department.
- C. Do not expose membrane or accessories to a constant temperature of 82°C (180°F) or above.
- D. Do not allow waste products (petroleum grease, oil or solvents, etc.) or direct steam venting to come in contact with the Custom Seal (PVC) roofing system. Any exposures not typical for normal roofing installation must be presented to Custom Seal Roofing Systems for assessment of any impact on the performance of the roofing system.
- E. Do not install Custom Seal (PVC) membrane directly over coal tar roof surfaces.
- F. Cements and solvents and their fumes contain petroleum distillates and are extremely flammable. Do not breathe vapors or use near fire. Care must also be exercised to ensure that open containers are not placed near fresh air intake ventilators on the roof. Consult container labels and Material Safety Data Sheets for specific information.
- G. All seaming and bonding surfaces must be dry and clean.
- H. Contact Custom Seal Roofing Systems Technical Department for procedures when installing Custom Seal (PVC) roofing systems during temperatures less than 4°C (40°F).
- I. Roofing surface must be free of ponded water, ice or snow prior to and during the roofing project.
- J. Rubber gloves are recommended when using any solvents or adhesives.
- K. Safety glasses, goggles or a face shield are recommended for eye protection.
- L. When using automatic heat welding equipment consult manufacturer's warnings.

1.06 WARRANTY- Refer to section 1.06 of the design section.

1.07 PRODUCTS- Refer to section 2.01 of the design section.

2.01 SUBSTRATE CRITERIA

- A. The building owner or owner's representative is responsible for providing and determining that the substrate is suitable to receive the Custom Seal (PVC) roofing system and the Custom Seal authorized contractor should not proceed until all defects have been corrected. If possible, install roofing system at the high point of the roof and work to the lowest point.
- B. Custom Seal Roofing Systems has compiled a list of the most common deck types found in the construction field. Custom Seal Roofing Systems strongly recommends that you review our requirements and restrictions prior to each roofing project. Refer to section 3.01 of the design section.

2.02 SUBSTRATE PREPARATION

- A. The building owner or owner's representative is responsible for ensuring that all wet insulation and/or substrate has been removed in a reroofing application. The best diagnostic technique is taking and evaluating a series of roof cuts. There are three other techniques that are currently available to make this determination by indirect means: nuclear moisture detection, infrared thermography and electric capacitance. These techniques provide measurements of factors that can be associated with the presence of moisture.
- B. It is recommended by the National Roofing Contractor's Association that there should be no ponding water on the roofing system 48 hours after it has stopped raining. A positive slope to facilitate drainage may be achieved with either structural slope or by using a tapered insulation roof substrate. Custom Seal PVC will not be adversely affected by ponding water.
- C. Existing sprayed-in-place urethane foam roofs must be removed prior to the installation of this roofing system.

2.03 INSTALLATION

- A. Insulation Selection
 - 1. Custom Seal Roofing Systems has certain requirements on insulation type, manufacturer, thickness, density and facer. Only insulations listed in 3.04 of the design section are to be used beneath the Custom Seal (PVC) mechanically attached system.
- B. Treated Wood Nailers
 - 1. Nailers must be pressure treated wood with salt preservatives. Creosote and asphaltic preservatives are not acceptable.
 - 2. Wood nailers are required along roof edges wherever metal gravel stops, drip edges or gutter systems are specified. Wood nailers are also required when roof curbs are to be mounted at finished roof level and not directly to the structural deck.

are specified. Wood nailers are also required when roof curbs are to be mounted at finished roof level and not directly to the structural deck.

3. Wood nailers must be equal in height to the roof insulation and be wider than the flange of the roof edge metal or curb being installed but not less than 3½" wide.
4. Wood nailers must be installed by an industry accepted method to resist 200 pounds (889N) of force in any direction with fasteners spaced a maximum of 24" apart.

C. Insulation Attachment

1. Secure the Custom Seal Insulation to the structural deck with one Custom Seal Fastener and Insulation Plate per 6.5 square feet, if using a 4'x4' insulation panel the securement of the insulation must be achieved with one fastener and plate per 4 square feet in order to attach the insulation in a manner to control bowing. Refer to the insulation attachment guidelines in the design section of this manual for securement patterns and fastener requirements.

NOTE: In the event the insulation is installed over an air barrier the insulation securement must meet FM 1-90 criteria for a Custom Seal Fully Adhered Roof System. This requirement is due to the fact that any uplift loading will be absorbed by the insulation over the air barrier in a manner similar to how an adhered assembly handles wind loading. Refer to the Design Criteria section for applicable insulation fastening rates.

D. Membrane

NOTE: The (PVC) membrane must be installed lines and dots up. The lines on the membrane are used to determine proper overlap.

1. Custom Seal 6' and 12' roll goods and factory fabricated panels of various widths can be used with the single weld systems.
2. Position the Custom Seal Membranes over approved substrate without stretching.

NOTE: It is recommended that when using Custom Seal panels that the material be unrolled and allowed to relax for as long as possible. This can be accomplished by stacking the unrolled sheets on top of one another in a location adjacent to the work area. When the material is needed, simply float the material into place as you would other single-ply membranes. This method will reduce fullness wrinkles and improve the dual weld seaming process.

3. Membrane should be allowed to relax as long as possible prior to any hot air welding.
4. Position all adjoining sheets in the same manner lapping edges a minimum of 4 1/2 " (11.4cm). Check overlap area for compliance. It is recommended that field sheets run perpendicular to the deck flutes to correctly engage the metal deck (Top Flutes) with the metal or polymer anchor bars.
5. Perimeter half sheet are required on mechanically attached roof systems in order to mitigate the effects of wind along the edges of the roof. In order to simplify the process of determining the perimeter area to be covered with half sheets, Custom Seal will accept the following assemblies for use on projects requiring a standard wind speed warranty. For buildings less than 50' tall a single half sheet (no more than 60% the width of the field panels) is required. For buildings between 51' and 75' tall two half sheets are required. On buildings higher than 75' contact the Custom Seal Technical Department for requirements or refer to the formula used by Factory Mutual in determining the perimeter area of roof requiring enhancement which is building height x 0.4= number of feet from the edge of the roof to be covered with half sheets, or 0.1 times the lessor plan dimension whichever is the lesser. For FM rated assemblies the Factory Mutual formula must be used on all projects, i.e. if a project calls for an assembly that has an FM rating then the FM formula must be used. Fastener spacing on half sheets is equal to the spacing used in the field of the roof. Increased securement in the perimeter area of the roof is achieved by reducing the panel width for the half sheets to no more than 60% of the width of the field sheet.
6. To determine fastener type and spacing requirements for membrane securement refer to the (PVC) Mechanically Secured Fastener Matrix in the back of this application section.
7. Any wrinkles found in the outside 1" minimum seam area (step-off), or if the wrinkle impedes the flow of water drainage, it must be cut, laid flat and repaired using PVC membrane over the cut area with standard heat welding procedures.

E. Seaming

1. Unroll the membrane and allow to relax as long as possible. (Minimum 1/2 - 1 hour)
2. Position the top membrane to overlap the bottom membrane panel by 4 1/2" (11.4cm) inches.
3. Using a clean rag saturated with Custom Seal Solvent Cleaner, thoroughly clean an area on both sheets at least 4 inches (10.2cm) wide if seam area has become contaminated with dirt, debris, etc. Change rags frequently to avoid depositing previously removed materials.
4. Fold back the top sheet and position the appropriate Custom Seal seam plates on the layout dots that have been applied to the edge of the membrane panel at 6" intervals as required for the specific system being installed, refer to the PVC Matrix for plate and fastener type as well as fastener spacing requirements. Fasten the seam plates through the membrane to the structural deck with approved fasteners. Follow appropriate fastener spacing or contact Custom Seal Technical Department.

5. Using an approved automatic heat welding machine or hand held heat gun and teflon roller, continuously weld a minimum 1½" (3.8cm) wide seam. Custom Seal recommends that only approved Automatic Walker Welders be used to weld all field seams (see Hot Air Welder Specifications).
 6. All welded seams must be manually checked for voids or seal deficiencies by probing the entire seam area with a dull cotter key extractor after the seam has cooled. In addition, there must be destructive testing performed daily at the beginning and every time there is an interruption in the welding process (i.e. Power failure, welder shut down, job site conditions change and after lunch). All deficiencies must be repaired.
 7. Seam areas where three (3) or more layers of reinforced membrane intersect will require the application of a 6" x 6" non-reinforced joint cover. These areas include but are not limited to dual welds, factory splices, etc.
- F. Perimeter Membrane Attachment
1. The Custom Seal (PVC) membrane must be securely attached to the approved roof substrate.
 2. Custom Seal Roofing Systems offers several different attachment methods. Consult Custom Seal (PVC) standard details.
 3. Perimeter membrane attachment is required at each roof level, curb, skylight, expansion joint and roof penetration and at any deck or substrate angle change greater than 2 / 12.
 4. Nailers must be pressure treated wood with salt preservatives. Creosote and asphaltic preservatives are not acceptable.
 - a. Wood nailers are required along roof edges wherever metal gravel stops , drip edges or gutter systems are specified. Wood nailers are also required when roof curbs are to be mounted at finished roof level and not directly to the structural deck.
 - b. Wood nailers must be equal in height to the roof insulation and be wider than the flange of the roof edge metal or curb being installed but not less than 3½" wide.
 - c. Wood nailers must be installed by an industry accepted method to resist 200 pounds (889N) of force in any direction with fasteners spaced a maximum of 24" apart.
- G. Flashing
1. Perimeter wall flashing, flashing around vents, skylights, and miscellaneous roof projections must be installed using Custom Seal (PVC) membrane, Custom Seal (PVC) metal, and/or Custom Seal (PVC) prefabricated corners and pipe boots. Custom Seal Roofing Systems offers numerous alternatives for flashings in our standard details.
- H. Night Seal
- At the completion of each day's work, temporarily seal any loose edge in such a way as to prevent water from flowing beneath any completed sections of roof. Consult Custom Seal Technical Services for methods of sealing the membrane to the deck if necessary to protect the completed system. If sealants or seam tapes are used in the assembly of the night seal the area of membrane affected must be removed the next work day before continuation of the roofing application.
- I. Walkways
1. If regular maintenance (once a month or more) is required to service rooftop units, Custom Seal walkway pads are recommended.
 2. Walkways are recommended at all traffic concentration points, such as roof hatches, access doors, rooftop ladders, etc., regardless of traffic frequency.
 3. Consult Custom Seal (PVC) standard details for attachment method.
 4. Walkways are considered a maintenance item and are not warranted by Custom Seal Roofing Systems.
 5. See 3.13 of the design section for approved list of walkways.
- J. Expansion Joints and Building Control Joints
1. Consult Custom Seal Roofing Systems standard details for various application methods.
- K. Pitch Pans
1. Fill pitch pans in accordance with Custom Seal Roofing Systems standard details.

L. Roof Drains

1. Prepare substrate around each roof drain to prevent any distortion or membrane bridging and to provide a smooth transition from the roof surface to the drain clamping ring.
2. The surfaces between the clamping ring and the drain must be clean and smooth. Remove all existing flashing, cement or lead on retrofit drains.
3. One (1) complete tube of Custom Seal Waterstop is required per drain.
4. **All bolts and/or clamps must be in place to provide constant even compression.**
5. Do not run seam through roof drain or sumps.

M. Metal Work

1. Supply and install metal work meeting project design requirements and SMACNA recommendations, refer to the general details section of this manual for Custom Seal installation requirements.
2. Nailers must be pressure treated wood with salt preservatives. Creosote and asphaltic preservatives are not acceptable.
 - a. Wood nailers are required along roof edges wherever metal gravel stops, drip edges or gutter systems are specified. Wood nailers are also required when roof curbs are to be mounted at finished roof level and not directly to the structural deck.
 - b. Wood nailers must be equal in height to the roof insulation and be wider than the flange of the roof edge metal or curb being installed but not less than 3½" wide.
 - c. Wood nailers must be installed by an industry accepted method to resist 200 pounds (889N) of force in any direction with fasteners spaced a maximum of 24" apart.

Mechanically Attached PVC Matrix

PVC System	Fastener	#14	#15 WH	#15 XHD (ASAP)	#15 WH	#15 WH	#16 MAX
	Plate/Bar	2in.	2-3/8 in. WH	2-3/8 in. XHD	Poly Bar	Metal Bar	3" MAX
	Weld	Single	Single	Single	Dual	Dual	Single
6 ft	FM I-60	na	na	na	18 in. o.c.	18 in. o.c.	na
	FM I-90	6 in. o.c.	12 in. o.c.	12 in. o.c.	12 in. o.c.	12 in. o.c.	na
	FM I-105	na	na	na	6 in. o.c.	6 in. o.c.	na
	FM I-120	na	na	na	6 in. o.c.	6 in. o.c.	na
	FM I-150	na	na	na	6 in. o.c.	6 in. o.c.	na
	54 mph	18 in. o.c.	18 in. o.c.	18 in. o.c.	18 in. o.c.	18 in. o.c.	na
6 ft	72 mhp	12 in. o.c.	18 in. o.c.	18 in. o.c.	18 in. o.c.	18 in. o.c.	na
	80 mph	6 in. o.c.	12 in. o.c.	12 in. o.c.	12 in. o.c.	12 in. o.c.	na
	90 mph	na	6 in. o.c.	6 in. o.c.	12 in. o.c.	12 in. o.c.	na
12ft	FM I-60	na	na	na	12 in. o.c.	12 in. o.c. **	12"***
	FM I-90	na	6 in. o.c.	na	see note G	6 in. o.c. **	6"***
	FM I-105	na	na	na	6 in. o.c.	6 in. o.c.	na
	FM I-120	na	na	na	6 in. o.c.*	6 in. o.c.*	na
	54 mph	na	12 in. o.c.	na	12 in. o.c.	12 in. o.c.	12"
	72 mhp	na	6 in. o.c.	na	12 in. o.c.	12 in. o.c.	6"
12ft	80 mph	na	na	na	12 in. o.c.	12 in. o.c.	na
	90 mph	na	na	na	6 in. o.c.	6 in. o.c.	na

* - Grade E deck at 5.5ft bar joist spacing

*** - Grade C or E deck

= Standard Warranted System

Notes:

A. 100 mph wind speed warranty fully adhered over OSB, contact Technical Department

B. For FM insured projects, contact Technical Department for deck requirements

C. Approved decks:
 22 ga. Steel
 Structural Concrete
 3/4 in. APA certified plywood or OSB
 2 in. wood plank

D. Custom Seal High Wind Design (80 & 90 mph) must be submitted to Technical Department prior to project bid. Pullout data is required.

E. Contact Custom Seal Technical Department for perimeter attachment requirements

F. FM I-90 Approved at 12 in. oc. for structural concrete, Grade E metal deck FM I-90 Approved at 6 in. o.c.

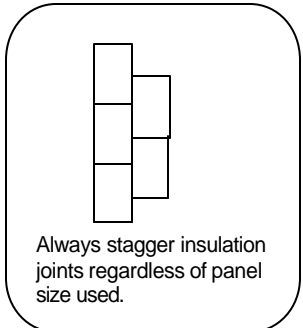
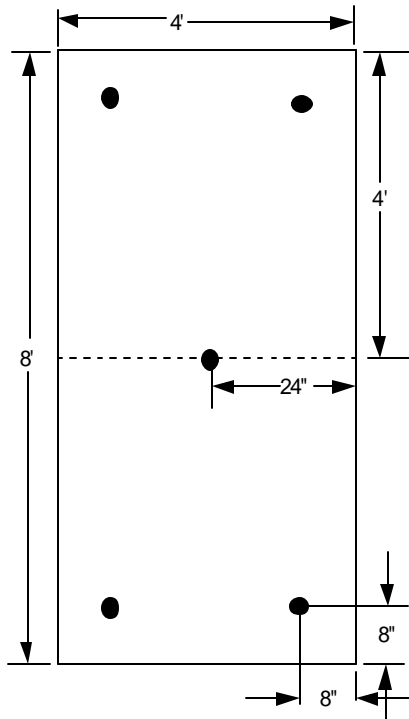

Always stagger insulation joints regardless of panel size used.

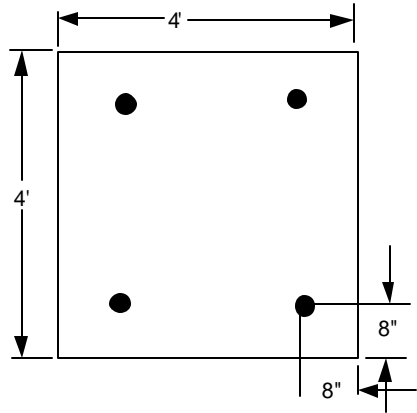

For use on buildings up to 15.2m (50') high. If building height exceeds 15.2m (50') high contact Custom Seal Roofing Systems for attachment pattern.

Insulation Securment For Mechanically Attached Systems	Detail #:42.08r	PVC Systems 1/03
---	------------------------	-------------------------

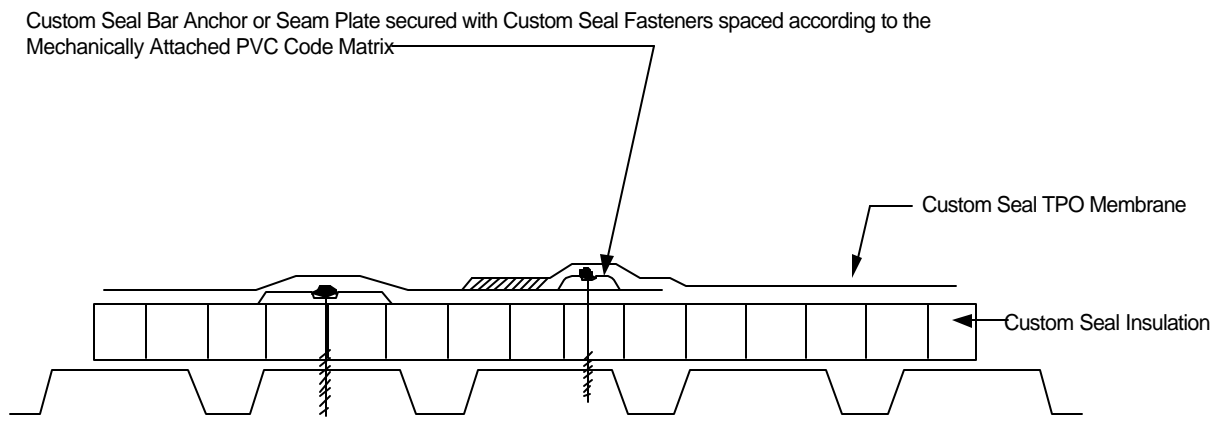

Position insulation and membrane sheets to enable securment into the top flutes on steel decks to ensure positive attachment and to reduce fastener movement. Insulation should be installed with board ends resting on the flute tops.

Mechanically Attached System Cross Section	Detail #:42.02sw	PVC Systems 1/03
---	-------------------------	-------------------------

For Use On Roofs 0' To 50' Above Ground Level

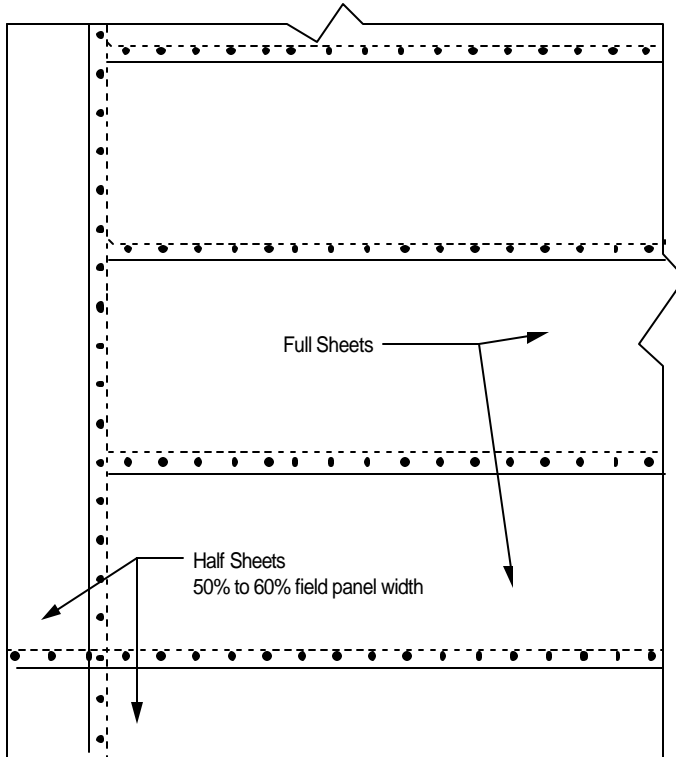

All Custom Seal PVC Mechanically Attached Systems require half sheet perimeter securement. A half sheet width of up to 60% of the width of the field panels may be used. Half sheet securement is equal to the membrane securement used in the field of the roof. See the Mechanically Attached PVCCode Matrix for fastener and spacing requirements. If the project must meet Factory Mutual criteria refer to detail 42.04-3 and contact Factory Mutual for review.

Half sheets are required at all exterior edges of the roof system and at the upper level edges of transitions in surface height greater than 3'

If the building being roofed has any of the following conditions contact Custom Seal Technical for assistance in determining half sheet requirements:

- A) Large wall openings totalling 10% or more of any wall area.
- B) Canopies open below the roof deck.
- C) In the immediate vicinity of large bodies of water or coastline.
- D) Building height in excess of 75'.

For projects requiring a warranty wind speed in excess of 54mph contact Custom Seal Technical Department for perimeter securement requirements - additional half sheets and / or fasteners and seam plates may be required.

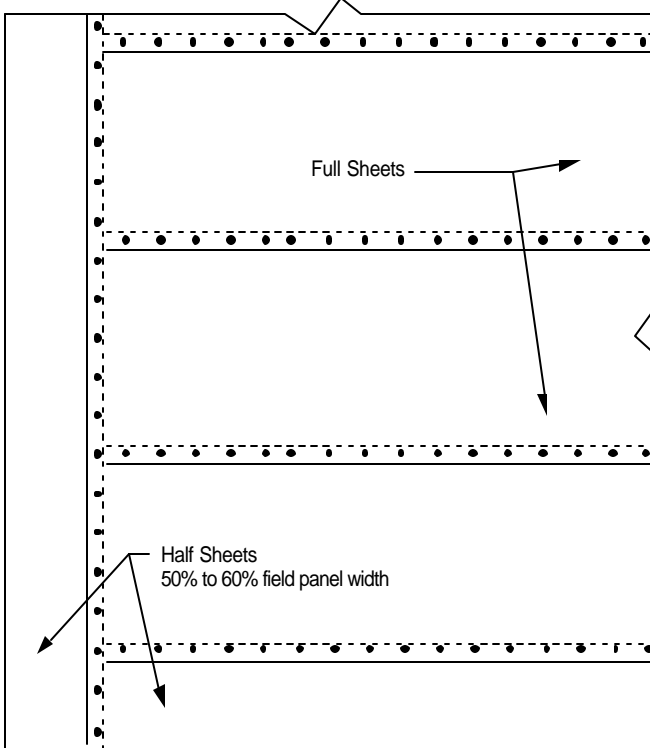

**Perimeter Securement Layout
For Std. Warranty 50' High or Less**

Detail #: 42.04-1

**PVC Systems
Mechanically Attached Only**

10/01

For Use On Roofs 50' To 75' Above Ground Level

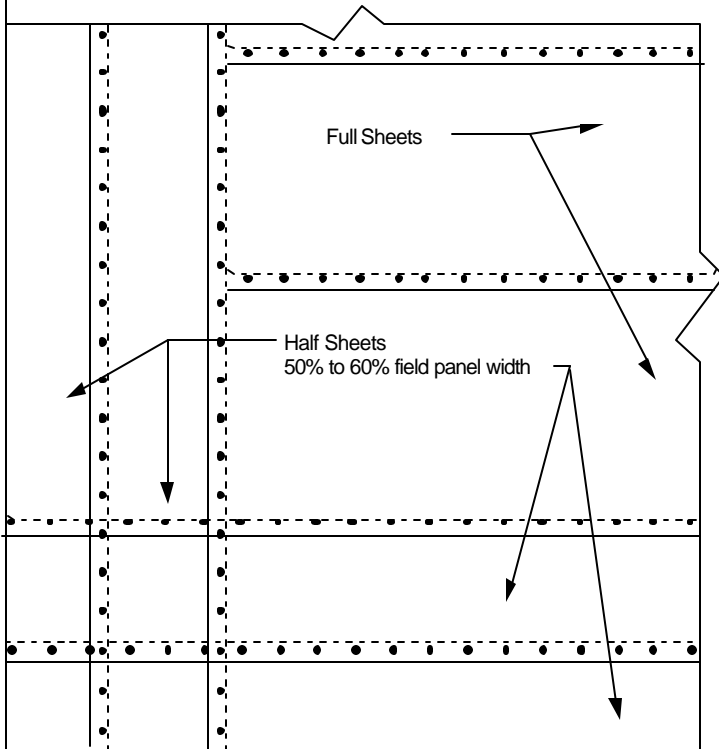

All Custom Seal Mechanically Attached Systems require half sheet perimeter securement. A half sheet width of up to 60% of the width of the field panels may be used. Half sheet securement is equal to the membrane securement used in the field of the roof. See the Mechanically Attached PVC Code Matrix for fastener and spacing requirements. If the project must meet Factory Mutual criteria refer to detail 42.04-3 and contact Factory Mutual for review.

Half sheets are required at all exterior edges of the roof system and at the upper level edges of transitions in surface height greater than 3'

If the building being roofed has any of the following conditions contact Custom Seal Technical for assistance in determining half sheet requirements:

- A) Large wall openings totalling 10% or more of any wall area.
- B) Canopies open below the roof deck.
- C) In the immediate vicinity of large bodies of water or coastline.
- D) Building height in excess of 75'.

For projects requiring a warranty wind speed in excess of 54mph contact Custom Seal Technical Department for perimeter securement requirements - additional half sheets and / or fasteners and seam plates may be required.

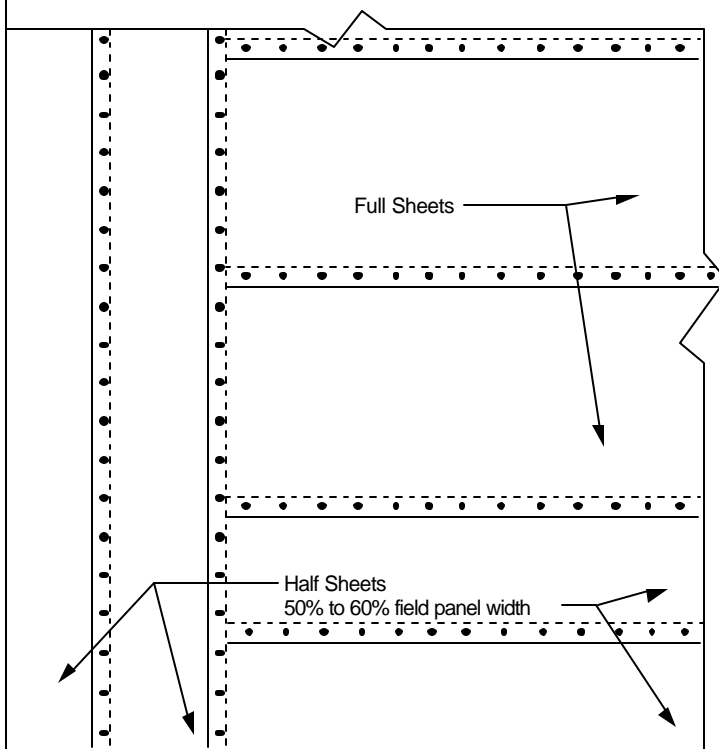

U3/02

**Perimeter Securement Layout
For Std. Warranty 50' to 75' High**

Detail #: CS 42.04-2

**(PVC) Systems
Mechanically Attached Only**

For Use On Roofs Requiring Factory Mutual Rating Compliance

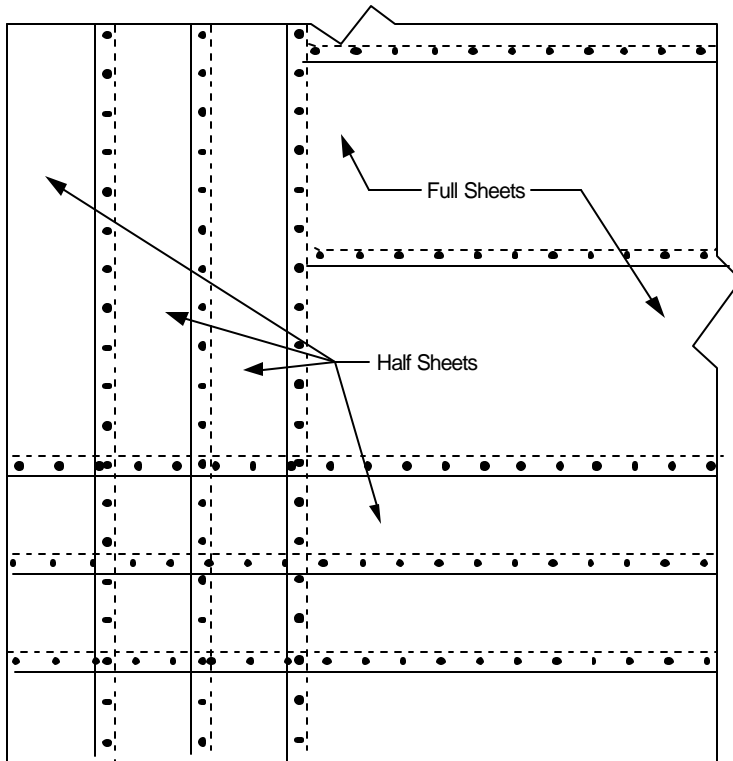

The width of the enhanced perimeter and corner securement areas on a Mechanically attached PVC roof system is determined by multiplying the building height by .4 or the lesser building dimension by .1 whichever is less. The perimeter area must be roofed with half sheets (half sheets up to 60% of the field sheet width are acceptable) secured at the same rate as the full width field sheets of membrane. The corner areas must be further enhanced as shown by criss crossing the half sheets in the corners. Caution: When installing to Factory Mutual requirements all fasteners used to enhance the corner areas must penetrate the uppermost layer seam assembly.

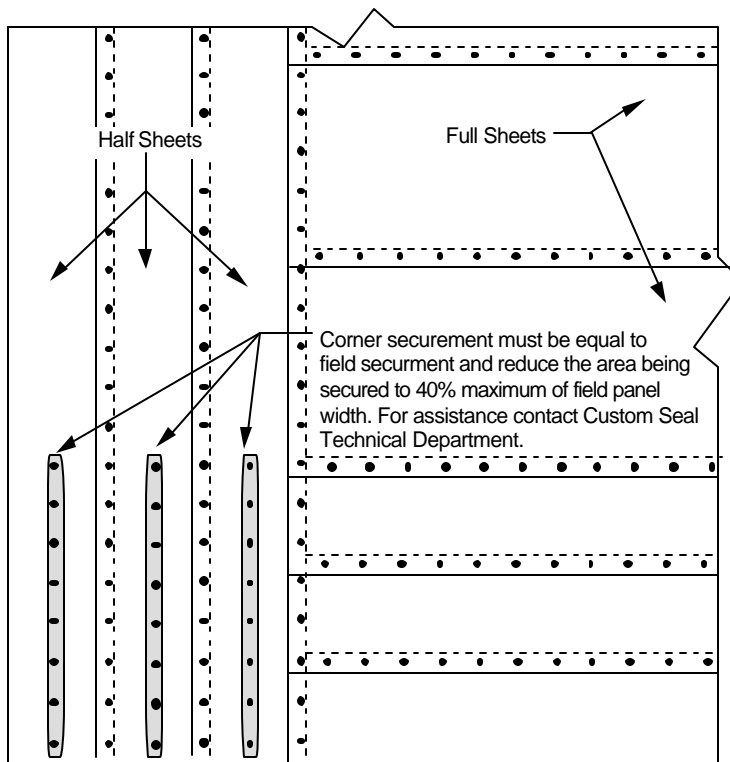

As an option, corner enhancement may be accomplished by installing additional rows of securement through the half sheets and then striping in those rows of securement with PVC flashing installed to Custom Seal specification.